

M

Stage monitors

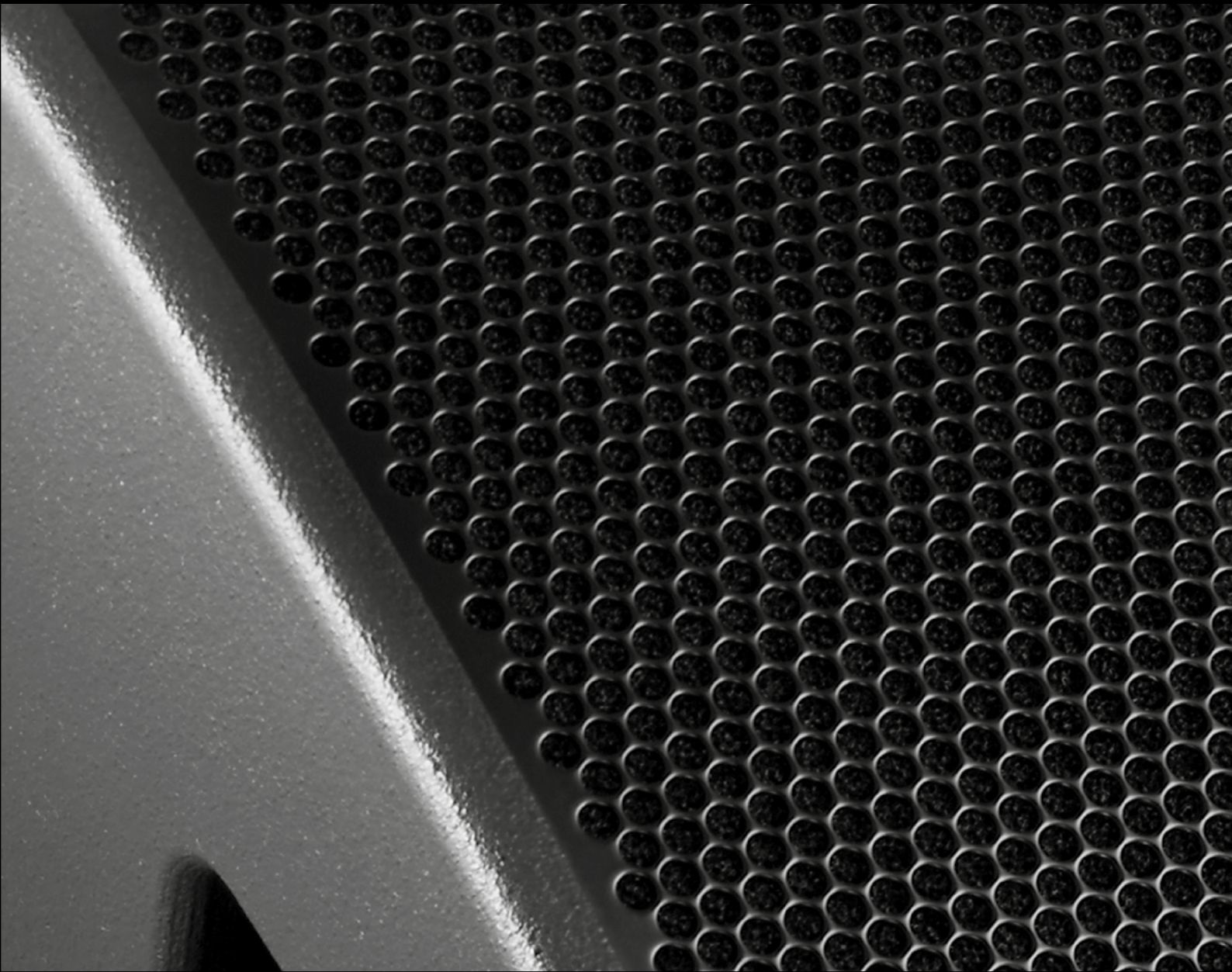

Contents



The d&b System reality	4
The Stage monitors	6
The MAX2 monitor	10
The M6 monitor	11
The M4 monitor	12
The M2 monitor	13
The Stage monitor cases	14
The MAX2 mounting accessories	16
The MAX2 mounting examples	17
The M6/M4/M2 mounting accessories	18
The M6/M4/M2 mounting examples	19
The d&b Remote network	20
The d&b amplifiers	22
The operation with d&b amplifiers	24
The Stage monitors frequency responses	25
The d&b amplifier output modes	26
The DS10 Audio network bridge	27
The Stage monitors cables and adapters	28
The Stage monitors product overview	30

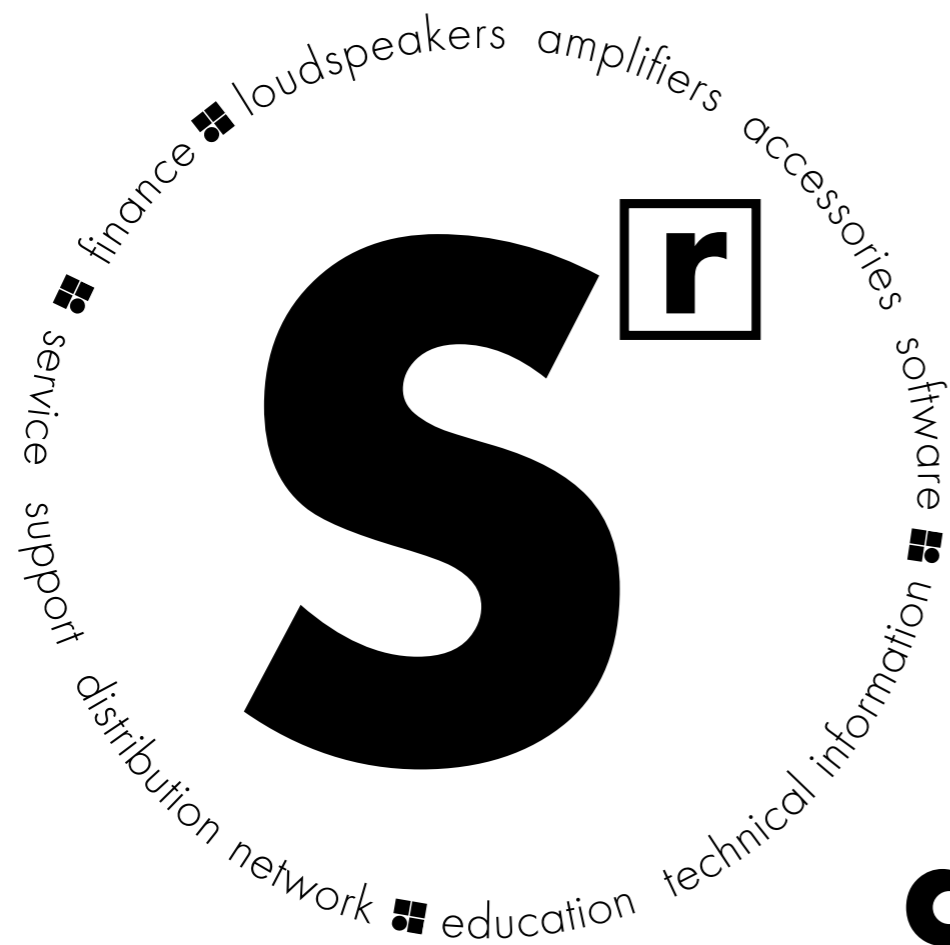

d&b System reality

As the name implies a d&b audiotechnik system is not just a loudspeaker. Nor is it merely a sum of the components: loudspeakers, amplifiers, accessories and software. Right from the outset the d&b audiotechnik approach was to build integrated sound reinforcement systems that actually are

more than the combination of parts: an entirety where each fits all. Every element is tightly specified, precisely aligned and carefully matched to achieve maximum efficiency. For ease of use, all the user-definable parameters are incorporated, allowing the possibility of adjustment, either via remote control surfaces

or directly on the amplifiers. Neutral sound characteristics leave the user all the freedom needed to realize whatever the brief. At the same time d&b offers finance, service and support, a knowledgeable distribution network, education and training as well as technical information, so the same optimal acoustic result

is achieved consistently by every system anywhere, at any time. In reality: the d&b System reality.

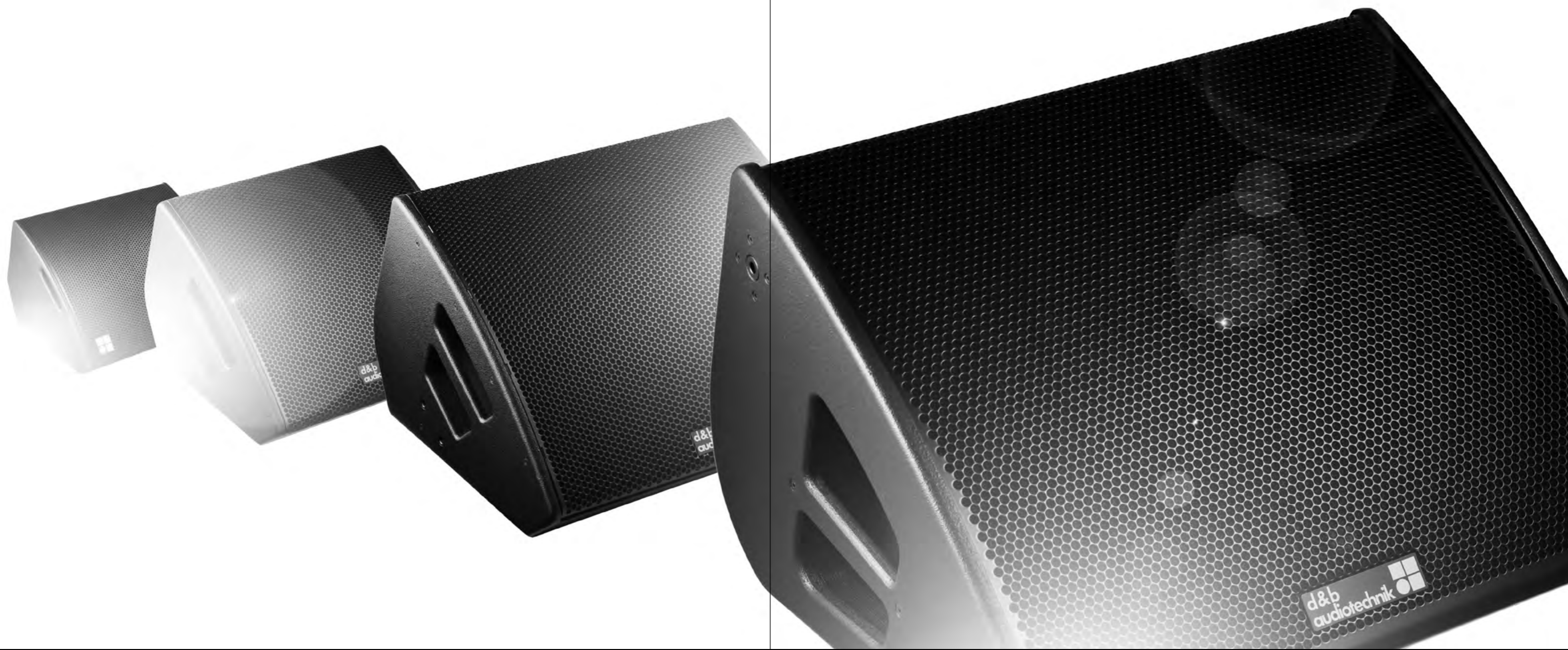

d&b **Stage monitors** can seriously enhance the performance of the artist and the success of a production. That's why d&b has always maintained that there should be no difference in

the quality of sound between front of house and the stage. Consequently the d&b Stage monitors have not only a low profile cabinet design for use in visually sensitive situations, but also

remarkable vocal presence and clarity and more than adequate power. With the well defined dispersion control the systems guarantee a high feedback stability realizing an efficient tool

and a neutral platform for the engineer and artist alike.

The Stage monitors

The 2-way passive **MAX2** features a 15" driver with a coaxially mounted 1.4" compression driver. The MAX2 is a stage monitor with remarkable vocal presence and clarity; a neutral, balanced sound; high feedback stability and sound pressure level capabilities. The MAX2 monitor is passively crossed over, and can be driven in dual channel mode using the specific setup in a d&b amplifier or by any other appropriate linear power amplifier. Specially designed runners prevent unwanted movement when used as a stage monitor, while the integrated pole mount makes the MAX2 suitable for small PA applications.



MAX2 monitor

The **M6** and **M4** are low profile 2-way high performance stage monitors employing an integrated 12"/1.3" and 15"/1.3" exit coaxial driver respectively, with a CD horn and passive crossover network. The M6 and M4 distinguish themselves through a remarkable midrange presence, the M4 additionally through a dry and deep low end. Combined with excellent feedback stability, high sensitivity and discreet designs they line up perfectly with the d&b M2 state of the art monitor.



M6 monitor



M4 monitor



M2 monitor

The **M2** is the d&b definitive actively crossed over reference stage monitor system. The bass-reflex enclosure is optimized for minimal air compression and houses two 12" LF drivers. The 1.4" exit HF compression driver operates into a very low distortion horn with a waveguide oriented design. This remarkable cabinet achieves a constant directivity of 45° x 60° (h x v) above the unusually low frequency of 600 Hz, resulting in substantial feedback stability and a very direct voice reproduction. Finally, its peak sound pressure level of 143 dB at 1m will satisfy even the unhealthiest of SPL requests.

d&b remote software creates a flexible user interface for the d&b user. The **R1** Remote control software provides all features, functions and controls available on the front of d&b amplifiers, which can be remotely controlled and monitored. Service functions enable firmware updates of the amplifiers as and when these are available, whilst monitoring tools such as System check verifies that the system performs within a predefined condition. R1 Remote control software incorporates the equalizer of each d&b amplifier channel within the software, to make adjustments at any position.

d&b amplifiers are specifically designed for use with d&b loudspeakers, and are at the heart of the d&b system approach. These devices contain extensive Digital Signal Processing capabilities to provide comprehensive loudspeaker management and specific switchable filter functions to precisely target the system response for a wide variety of applications. The four channel **D80** amplifier is intended for both mobile and installation applications requiring the highest Sound Pressure Levels. The four channel **D20** amplifier is specifically designed for mobile events comprising small to medium sound reinforcement solutions. The installation specific four channel **30D** amplifier is intended for rider driven live performance spaces which require medium to high Sound Pressure levels. These d&b amplifiers all provide four truly independent channels as well as extensive user-definable equalization containing two 16-band equalizers with parametric, notch, shelving and asymmetric filters.



D80 amplifier



D20 amplifier



30D amplifier

The **DS10** Audio network bridge provides 16 AES3 outputs and interfaces between the Dante audio transport protocol and the d&b amplifiers.



DS10 Audio network bridge

The MAX2 monitor

MAX2 monitor

The 2-way passive MAX2 loudspeaker houses a 1.5" LF driver and a coaxially mounted 1.4" HF compression driver and achieves 75° conical constant directivity dispersion.

The driver arrangement uses a single magnet assembly, allowing for a compact cabinet design with a low profile for strict visual demands.

The MAX2 can be driven by any appropriate linear power amplifier, but for maximum performance and protection a d&b amplifier is required. The MAX2 provides a broad variety of deployment possibilities, whether used individually as a stage monitor; as a stand-alone full range system or, when combined with d&b subwoofers, as a drumfill.

The loudspeaker cabinet is constructed in marine plywood with an impact resistant paint finish. Four M10 threaded inserts allow connection to a flying bracket. The cabinet incorporates a pair of recessed grips for handling, while the front is protected by a rigid metal grill backed with an acoustically transparent foam. A pole mount is incorporated into one of the side panels. Two runners recessed in the bottom panel protect the cabinet from scratching and prevents movement.

System data

Frequency response (-5 dB)..... 55 Hz - 20 kHz
 Max. sound pressure (1 m, free field)¹
 with D6/10D 131 dB
 with D20/30D 135 dB
 with D80 135 dB
 Input level (100 dB SPL/1 m).....
 passive -17 dBu

Loudspeaker data

Nominal impedance 8 ohms
 Power handling capacity (RMS/peak 10 msec) 250/1600 W
 Nominal dispersion angle (conical) 75°
 Components 1.5" driver with ferrite magnet
 coaxial 1.4" exit compression driver
 passive crossover network
 Connections 2 x NLT4 F/M
 optional 2 x EP5 or 2 x NL4
 Weight 23 kg (50 lb)

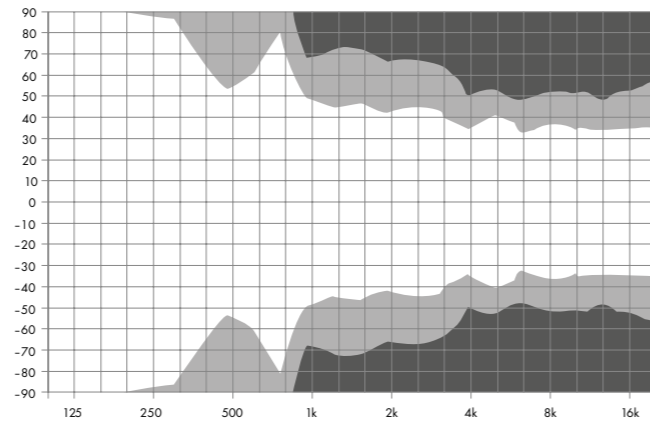

MAX2 dispersion characteristics²

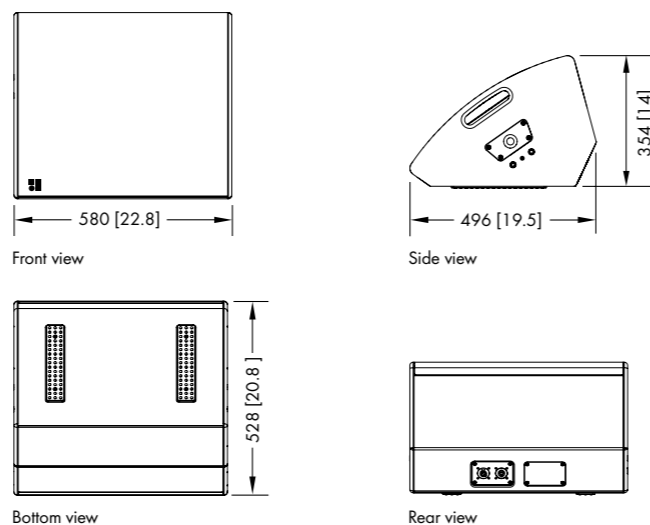

MAX2 cabinet dimensions in mm [inch]

¹ Broadband measurement, pink noise, crest factor 4, peak measurement, linear weighting
² Dispersion angle vs frequency plotted using lines of equal sound pressure (isobars) at -6 dB and -12 dB

The M6 monitor

M6 monitor

The M6 is a 2-way high performance stage monitor employing an integrated 12" LF and 1.3" exit horn loaded HF coaxial driver design that utilizes neodymium magnets. The constant directivity dispersion of 50° x 80° (h x v), which this unique horn provides, delivers an accurately defined coverage area on stage. The M6 can also be operated in 2-Way Active mode.

When the cabinet is used in an upright position the M6 serves as a powerful PA loudspeaker with a 80° x 50° dispersion suitable for a variety of applications. For dedicated installation applications the dispersion characteristics of the M6 driver assembly can be rotated.

The M6 cabinet is constructed from marine plywood, which incorporates the handles, has an impact resistant paint finish, M10 threaded inserts and a socket to accept loudspeaker stands. The front of the loudspeaker cabinet is protected by a rigid metal grill backed with an acoustically transparent foam. Two runners recessed in the bottom panel protect the cabinet from scratching and prevents movement.

System data, passive mode • 2-Way Active mode

Frequency response (-5 dB)..... 65 Hz - 17 kHz
 Max. sound pressure (1 m, free field)¹
 with D6 passive mode 132 dB
 with 10D 132 • 133 dB
 with D20/30D 135 • 138 dB
 with D80 135 • 138 dB
 Input level (100 dB SPL/1 m).....
 passive/active -22 dBu/-22 dBu

Loudspeaker data

Nominal impedance 8 ohms
 Power handling capacity (RMS/peak 10 msec) 400/1600 W
 Nominal dispersion angle (h x v) 50° x 80°
 Components 12" driver with neodymium magnet
 coaxial 1.3" exit compression driver with 3" coil and CD horn
 passive crossover network
 Connections 2 x NLT4 F/M
 optional 2 x EP5 or 2 x NL4
 Weight 16 kg (35 lb)

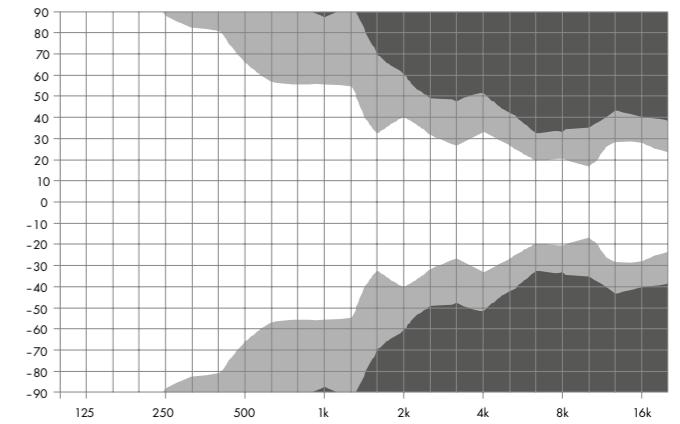

M6 horizontal dispersion characteristics²

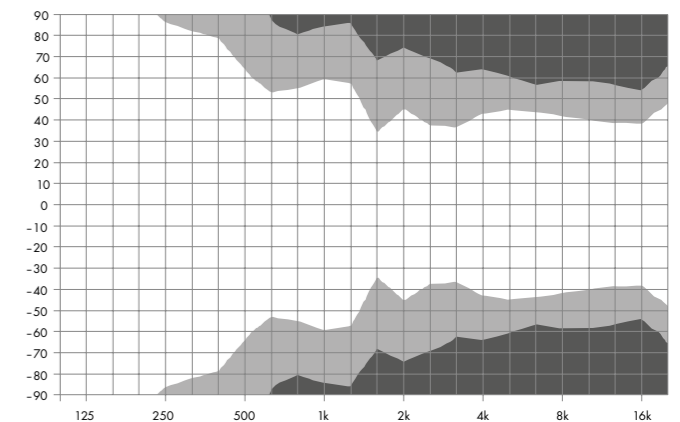

M6 vertical dispersion characteristics²

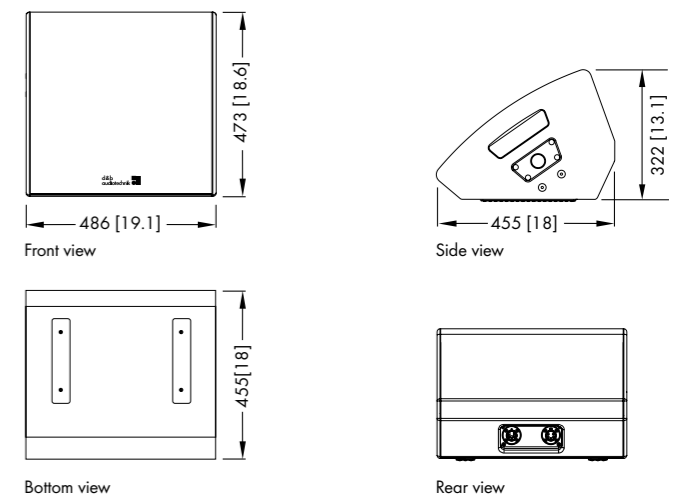

M6 cabinet dimensions in mm [inch]

¹ Broadband measurement, pink noise, crest factor 4, peak measurement, linear weighting
² Dispersion angle vs frequency plotted using lines of equal sound pressure (isobars) at -6 dB and -12 dB

The M4 monitor

M4 monitor

The M4 is a 2-way high performance stage monitor employing an integrated 1.5" LF and 1.3" exit horn loaded HF coaxial driver design that utilizes neodymium magnets. The constant directivity dispersion of 50° x 70° (h x v), which this unique horn provides, delivers an accurately defined coverage area on stage. The M4 can also be operated in 2-Way Active mode.

When the cabinet is used in an upright position the M4 serves as a powerful PA loudspeaker with a 70° x 50° dispersion suitable for a variety of applications. For dedicated installation applications the dispersion characteristics of the M4 driver assembly can be rotated in 45° increments.

The M4 cabinet is constructed from marine plywood, which incorporates the handles, has an impact resistant paint finish, M10 threaded inserts and a socket to accept loudspeaker stands. The front of the loudspeaker cabinet is protected by a rigid metal grill backed with an acoustically transparent foam. Two runners recessed in the bottom panel protect the cabinet from scratching and prevents movement.

System data, passive mode • 2-Way Active mode

Frequency response (-5 dB).....	55 Hz - 17 kHz
Max. sound pressure (1 m, free field) ¹	
with D6 passive mode.....	134 dB
with 10D	134 • 135 dB
with D20/30D.....	138 • 140 dB
with D80	138 • 140 dB
Input level (100 dB SPL/1 m).....	
passive/active.....	-22 dBu/-22 dBu

Loudspeaker data

Nominal impedance.....	8 ohms
Power handling capacity (RMS/peak 10 msec)	400/1600 W
Nominal dispersion angle (h x v).....	50° x 70°
Components.....	1.5" driver with neodymium magnet coaxial 1.3" exit compression driver with 3" coil and CD horn passive crossover network
Connections	2 x NLT4 F/M optional 2 x EP5 or 2 x NL4
Weight.....	20 kg (44 lb)

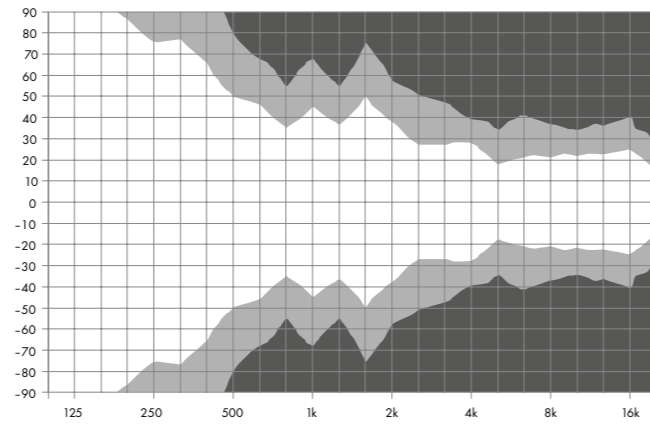

M4 horizontal dispersion characteristics²

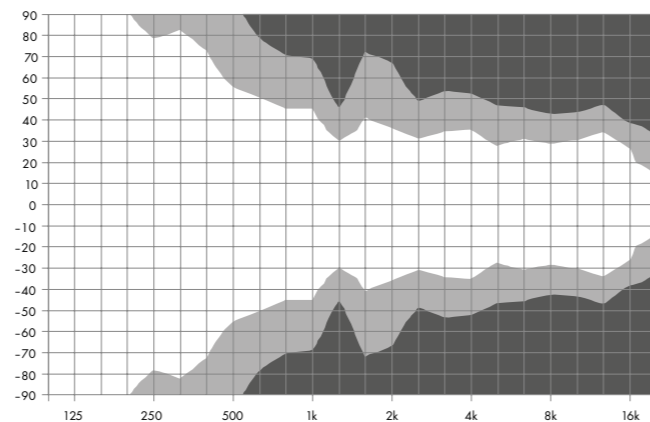

M4 vertical dispersion characteristics²

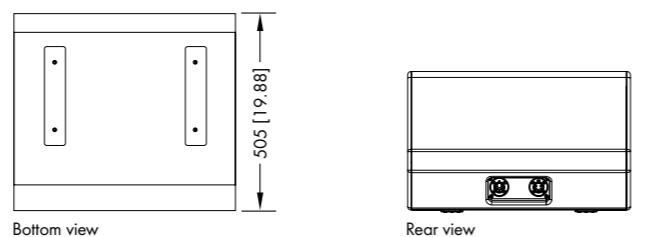
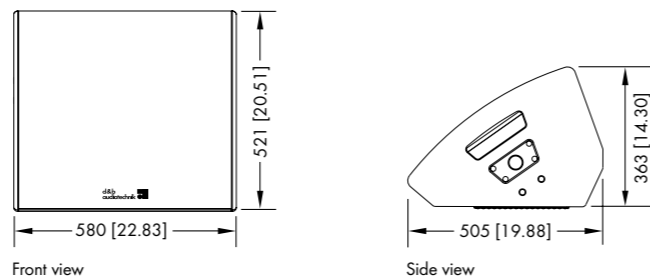

M4 cabinet dimensions in mm [inch]

¹ Broadband measurement, pink noise, crest factor 4, peak measurement, linear weighting
² Dispersion angle vs frequency plotted using lines of equal sound pressure (isobars) at -6 dB and -12 dB

The M2 monitor

M2 monitor

The M2 is the definitive high performance loudspeaker for stage monitoring purposes. The bass-reflex enclosure is optimized for minimal air compression and houses two 12" LF drivers. It is actively crossed over and powered by both channels of an appropriate d&b amplifier. The 1.4" exit HF compression driver has a compact but strong neodymium magnet assembly operating into a very low distortion waveguide oriented horn, optimized for monitor applications. The component configuration permits the use of a low profile cabinet which achieves a constant directivity from an unusually low frequency of 600 Hz upwards with a nominal dispersion of 45° x 60° (h x v). Together with a cabinet baffle angle of 40° to the floor, this dispersion offers a realistic artist listening area starting directly above the cabinet and ranging quite far upstage.

The M2 bestows its full dynamics across the entire frequency range without compromising the solo voices or instruments, which always stay clearly and audibly in front of the mix. The M2 cabinet is constructed from marine plywood and has an impact resistant paint finish. The cabinet is protected by a rigid metal grill backed with an acoustically transparent foam. Two fittings that accept the Flying pin 10 mm are located on both sides of the cabinet allowing quick and flexible rigging.

System data

Frequency response (-5 dB).....	50 Hz - 17 kHz
Max. sound pressure level (1 m, free field) ¹	
with 30D	143 dB
with D80	143 dB
Input level (100 dB SPL/1 m).....	-26 dBu

Loudspeaker data

Nominal impedance LOW/HIGH	4/8 ohms
Power handling capacity LOW (RMS/peak 10 msec).....	500/2000 W
Power handling capacity HIGH (RMS/peak 10 msec)	50/200 W
Dispersion characteristics (h x v)	45° x 60°
Components.....	2 x 12" driver 1.4" compression driver with CD horn
Connections	2 x NLT4 F/M optional 2 x EP5 or 2 x NL8
Weight.....	38 kg (83 lb)

¹ Broadband measurement, pink noise, crest factor 4, peak measurement, linear weighting
² Dispersion angle vs frequency plotted using lines of equal sound pressure (isobars) at -6 dB and -12 dB

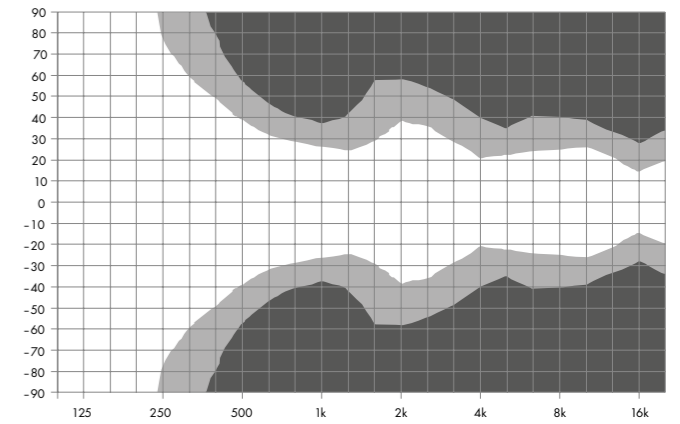

M2 horizontal dispersion characteristics²

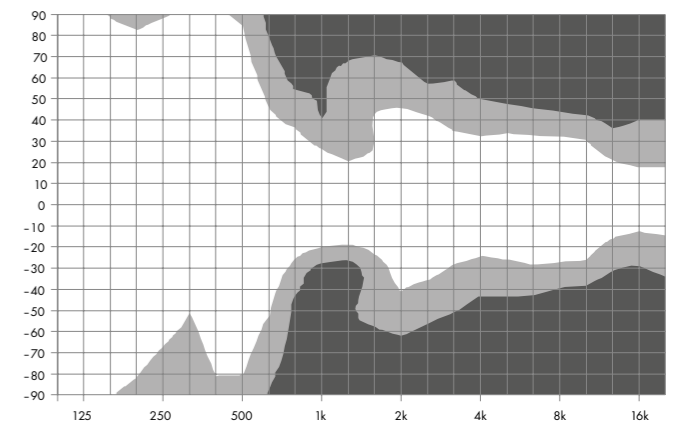

M2 vertical dispersion characteristics²

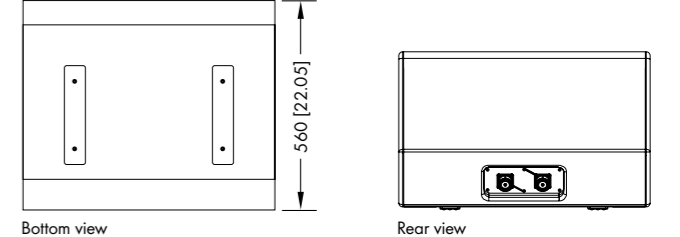
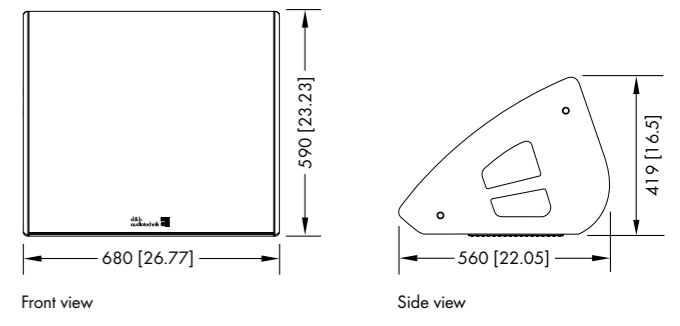

M2 cabinet dimensions in mm [inch]

The Stage monitor cases

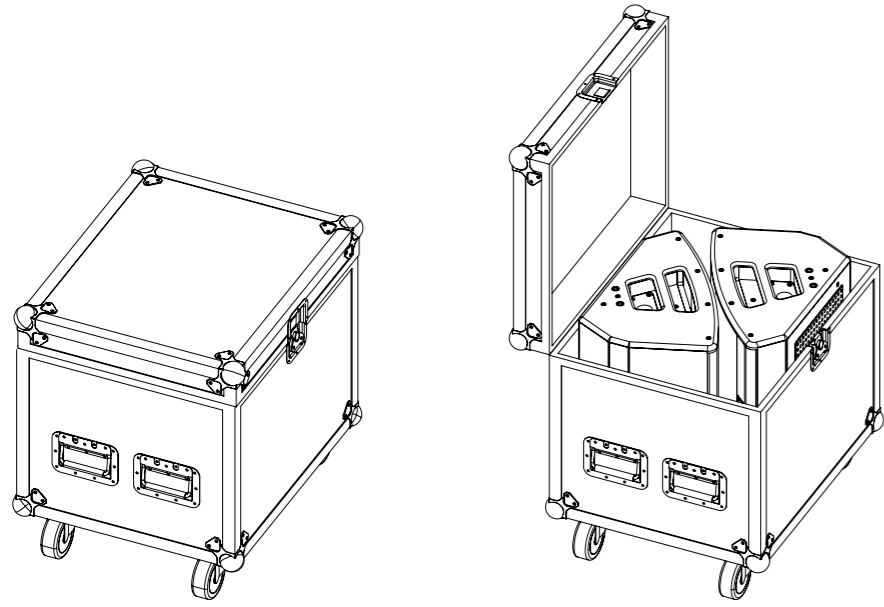

E7437
Touring case 2 x M6

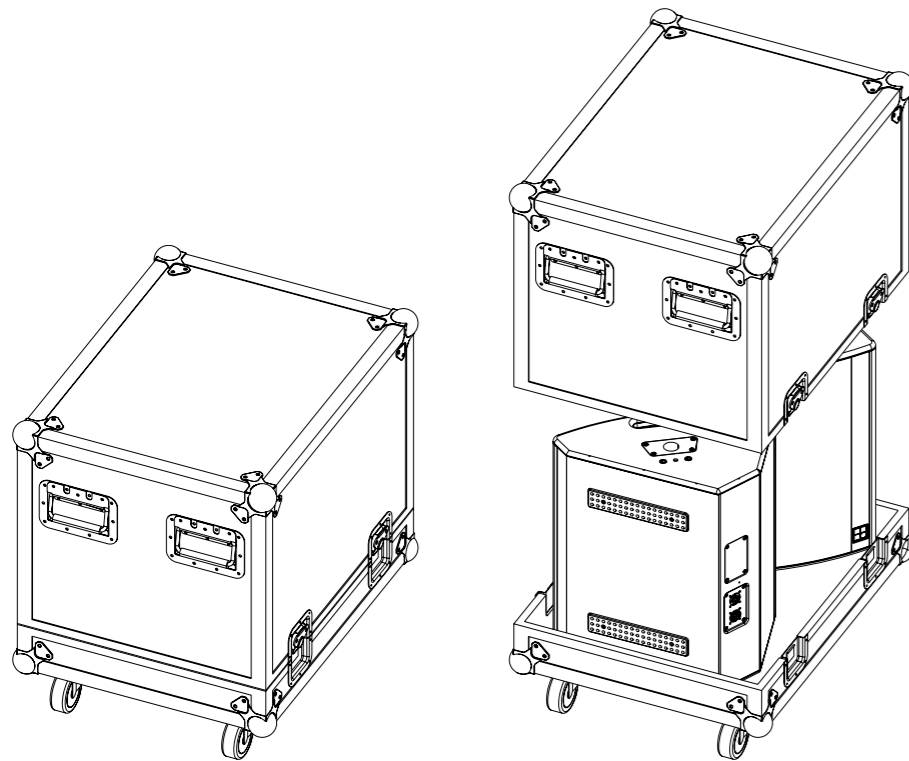

E7467
Touring case 2 x MAX2/M4

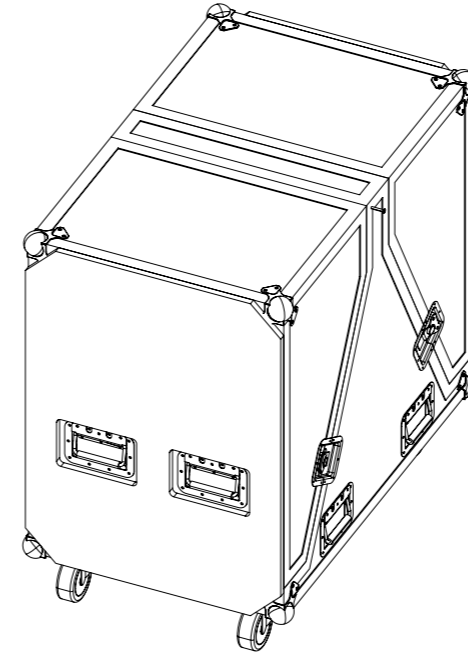

E7425
Touring case 2 x M2

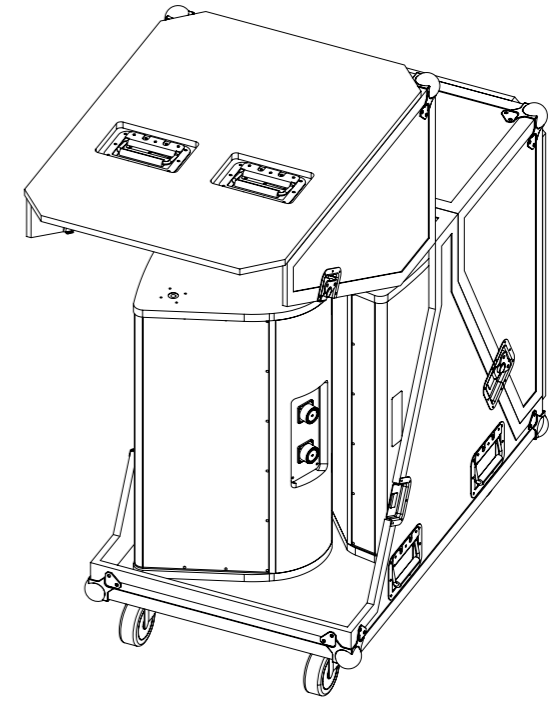

The MAX2 mounting accessories

Safety approval

d&b loudspeakers and accessories are designed for setup and use within situations requiring compliance with the provisions and directives of the DGUV regulation 17 (formerly BGV C1).

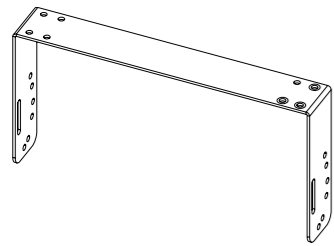

Z5043
MAX Horizontal bracket

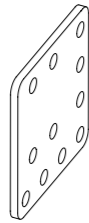

Z5044
MAX Bracket connector

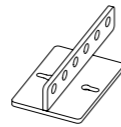

Z5020
Flying adapter 02

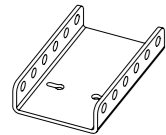

Z5025
Flying adapter 03

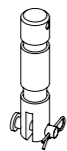

Z5015
TV spigot 02



Z5012
Pipe clamp for TV spigot
For a tube diameter up to 70 mm/2.75"

The MAX2 mounting examples

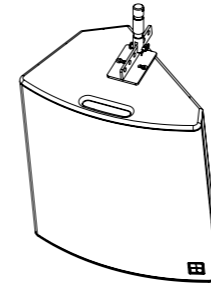

MAX2 with
Z5020 Flying adapter 02
Z5015 TV spigot 02

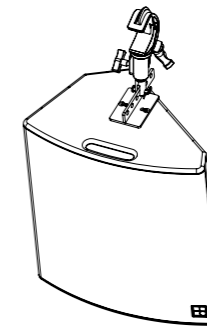

Y7P/Y10P with
Z5399 YP Mounting bracket
Z5010 TV spigot with fixing plate
Z5012 Pipe clamp

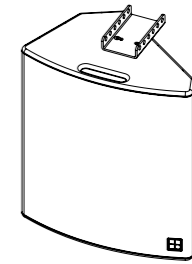

MAX2 with
Z5025 Flying adapter 03

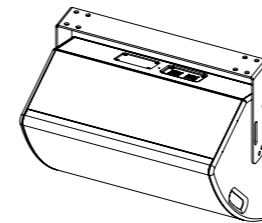

MAX2 with
Z5043 MAX horizontal bracket

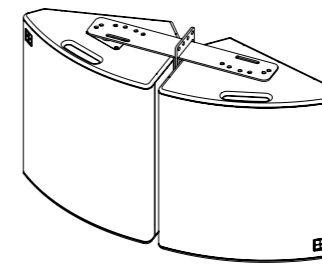

MAX2 array with
Z5043 MAX Horizontal bracket
Z5044 MAX Bracket connector

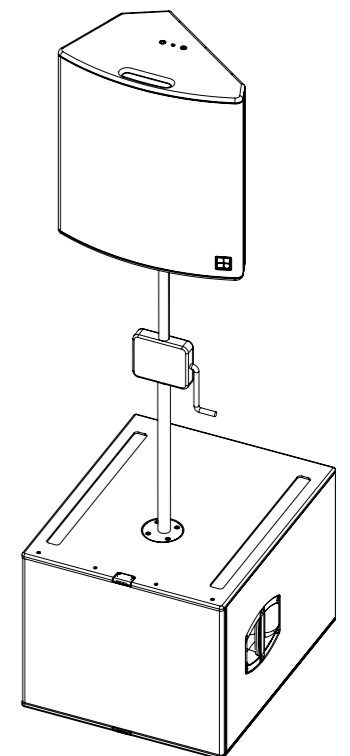

MAX2 with
Z5013 loudspeaker stand winder M20

The M6/M4/M2 mounting accessories

The M6/M4/M2 mounting examples

Safety approval

d&b loudspeakers and accessories are designed for setup and use within situations requiring compliance with the provisions and directives of the DGUV regulation 17 (formerly BGV C1).

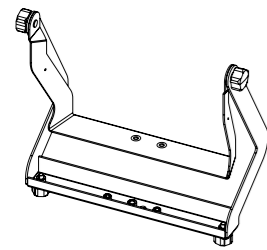

Z5057
M6 Flying bracket

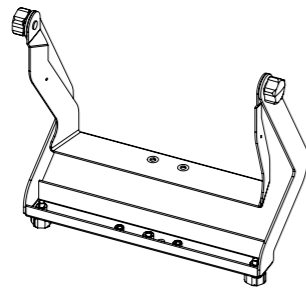

Z5056
M4 Flying bracket

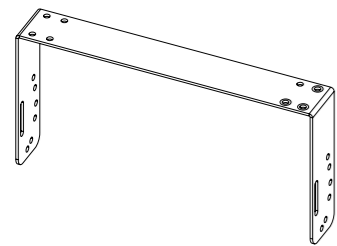

Z5047
MAX12 Horizontal bracket

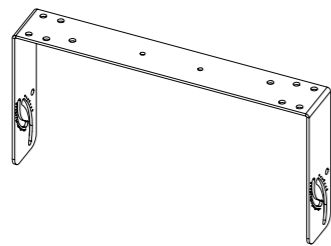

Z5175
Qi Horizontal bracket



Z5044
MAX Bracket connector

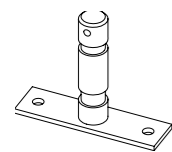

Z5010
TV spigot with fixing plate



Z5012
Pipe clamp for TV spigot
For a tube diameter up to 70 mm/2.75"

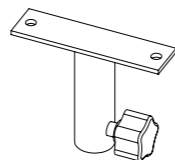

Z5024
Loudspeaker stand adapter

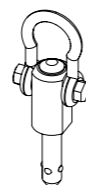

Z5048
Flying pin 10 mm

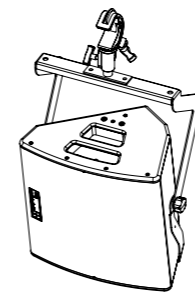

M6/M4 with
Z5057/Z5056 M6/M4 Flying brackets
Z5010 TV spigot with fixing plate
Z5012 Pipe clamp for TV spigot

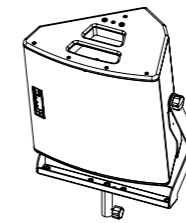

M6/M4 with
Z5057/Z5056
M6/M4 Flying bracket
Z5024 Loudspeaker
stand adapter

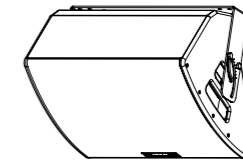

M6/M4 with
Z5047 MAX12 Horizontal bracket/
Z5175 Qi Horizontal bracket

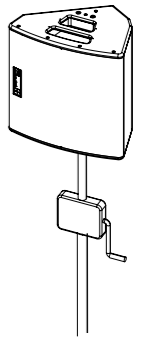

M6/M4 with
Z5009 Loudspeaker
stand with winder or
Z5013 Loudspeaker
stand winder M20

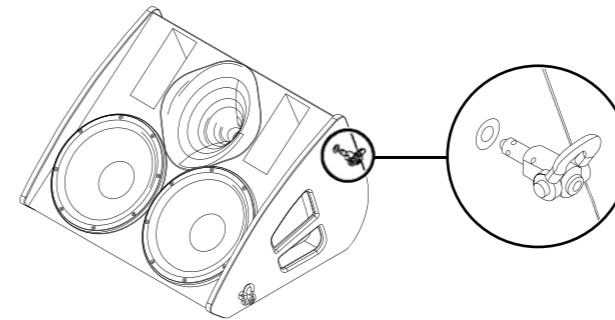

M2 monitor with Z5048 Flying pin 10 mm

The d&b Remote network

d&b Remote network

The remote control capability of the d&b Remote network enables central control and monitoring of a complete d&b loudspeaker system from anywhere in the network, be it from a laptop in the control room, at the mix position, or on a wireless tablet computer in the auditorium. This central access to all functions through the d&b Remote network, to controls as well as detailed system and device diagnostics information, unlocks the full potential of the d&b system approach. In the typical user workflow, the d&b Remote network takes settings optimized in the ArrayCalc simulation software and applies these to all the amplifiers within the network. In mobile situations R1 provides extensive functionalities for storing and recalling system settings, enabling setups to be repeated as and when required. Project files can be adjusted for use with different equipment at another location. d&b System check verifies that the system performs within a predefined condition. For permanent installations, system integrators can configure the d&b Remote network to allow access to different levels of control, according to the operational needs of the venue. R1 Remote control software enables d&b amplifiers to be remotely controlled, using both Ethernet and CAN-Bus in parallel. The software is optimized for use with touchscreen, mouse and keyboard and runs on both Microsoft Windows¹ (Win7 or higher) and Mac OS X² (10.7 or higher) operating systems. Password protection is available to restrict access.

R1 Remote control software

The R1 Remote control software provides a flexible workplace for the d&b user. All features, functions and controls are accessible via the front panel of d&b amplifiers, which can be remotely controlled and/or monitored using R1 Remote control software. It allows each channel of the amplifier to be controlled and enables the creation of groups of loudspeakers. When grouped together, a button or fader can control the overall system level, zone level, equalization and delay, system power ON/OFF, MUTE as well as loudspeaker specific function switches, such as CUT/HFA/HFC, CPL and ArrayProcessing. An offline mode is provided for preparation in advance of an event, without the need for amplifiers being present or connected.

The Home view provides an overview of all views in R1 and access to all user defined remote views. The Home button featured on each view returns directly to the Home view. The Open views bar offers quick navigation to any open view. Each user definable Remote view can be populated with control



Home



Remote in Configuration mode

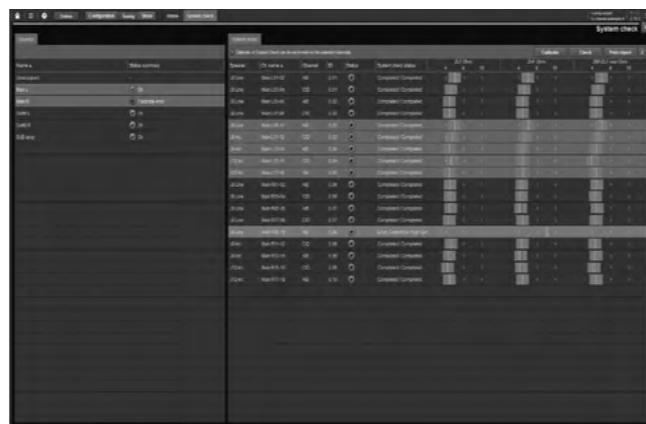

System check

functions of the system and can be optimized for different screen resolutions, either for large monitors or for smaller tablet devices.

Equalizer

The R1 Remote control software provides enhanced equalization functionalities for the d&b amplifiers, via an easy to use and efficient user interface. R1 accesses the 4-band equalizer in both channels of the D6 amplifier, or the two 16-band equalizers in each of the four channels of the D20 and D80 amplifiers. The system technician can use one D20/D80 16-band equalizer, lock it, and offer the second EQ to the visiting sound engineer for artistic adjustments. The R1 software enables an instant A/B comparison of two different equalizer curves. The D6 equalizer includes parametric and notch filters types, while the D20 and D80 equalizers also incorporate shelving and asymmetric filters. All filters available in the d&b amplifiers can be manipulated in R1 for fine adjustment; simple and intuitive control, via touchscreen or mouse and keyboard.

Service functions

R1 enables the simultaneous firmware update of multiple amplifiers from a central location. The software will automatically search the d&b website and on demand, downloads the latest available amplifier firmware versions and R1 Remote control software updates. Defined settings can be created, saved on a computer and loaded into amplifiers, for example to ensure that configuration switches are set to a known status, or the user definable equalization is set flat. Settings can be copied to additional or spare amplifiers. A Wink function is included to provide an effective method of locating specific amplifiers; this flashes the amplifier display. For service purposes, information may be read from an amplifier, concerning its condition during operation and errors reported. When additional support is required, the error report can be saved and sent to the d&b service departments for further assessment and diagnosis. The R1 Remote control software V2 and video tutorials are available at www.dbaudio.com.

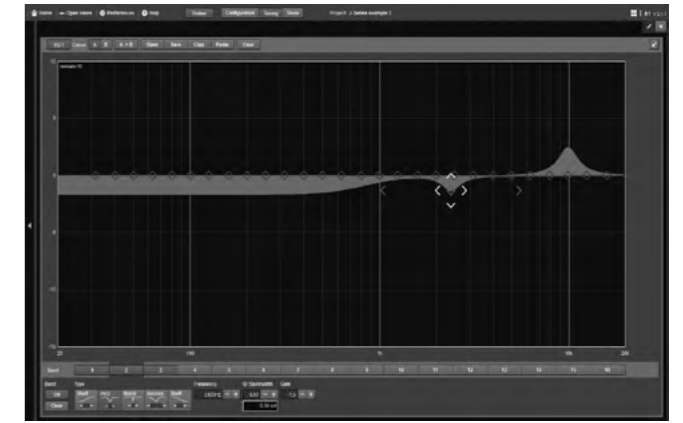

D20/D80 16-band equalizer

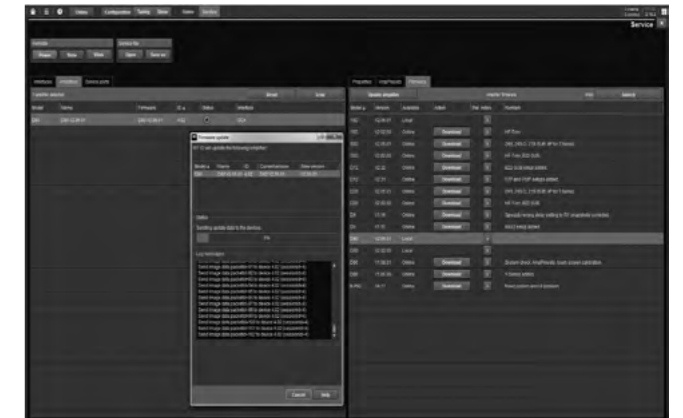

Service, Firmware update

¹ Microsoft Windows is a registered trademark or trademark of Microsoft Corporation in the United States and/or other countries

² Mac OS X is a trademark of Apple Inc., registered in the U.S. and other countries

The d&b amplifiers

The d&b amplifiers are designed specifically to power d&b loudspeakers and are the beating heart of the d&b System reality. As such, they incorporate Digital Signal Processing for comprehensive loudspeaker management, switchable filter functions, remote capabilities and user-definable controls, to fulfil the exact needs of each application. Every loudspeaker configuration combines comprehensive system limiting, and equalization and crossover settings to ensure consistent results and optimal performance. d&b amplifiers offer

different output configurations for different loudspeaker setups, including Dual Channel mode, for passive setups, Mix TOP/SUB mode, in which two channels are driven through a single output connector, and 2-Way Active mode, which also sends the output of two channels down one connector to drive appropriate loudspeakers actively. The d&b switch functions provide selected filters to precisely tailor a wide variety of setups to their applications. Examples of these switch functions are the CSA (Cardioid Subwoofer Array)

and HFC (High Frequency Compensation) modes. CSA increases low frequency directivity control by minimising energy transmission towards the rear while HFC compensates for air absorption for loudspeakers covering far field listening positions. In addition to these functions, d&b amplifiers offer a comprehensive set of specific filters such as CUT, a cut mode for TOP loudspeakers when used with d&b subwoofers; CPL, to compensate for the coupling effect between loudspeakers in close proximity to other loudspeakers or hard objects and HFA

mode, to attenuate the high frequencies of a loudspeaker to mimic the effect of far field listening. These devices offer extended, user-definable equalization and delay capabilities, eliminating the need for external processing devices in the signal chain. All d&b amplifiers integrate with the d&b Remote network to enable the remote control and management of systems from anywhere within a network. Further information is provided in the d&b Amplifier and Software brochure which is available for download at www.dbaudio.com.

Comparison of the d&b amplifiers

	D80	D20	30D	10D	D6
User interface	Encoder/colour TFT touchscreen	Encoder/colour TFT touchscreen	LED indicators	LED indicators	Encoder/LC display
Output channels	4	4	4	4	2
Input channels	4 x AES3 or 4 x analog or 2 x AES3 and 2 x analog	4 x AES3 or 4 x analog or 2 x AES3 and 2 x analog	4 x AES3 and 4 x analog	4 x AES3 and 4 x analog	2 x AES3 or 2 x analog
Latency	0.3 msec	0.3 msec	0.3 msec	0.3 msec	0.3 msec
User equalizers (per channel)	2 x 16-band	2 x 16-band	2 x 16-band	2 x 16-band	4-band
Delay	10 sec/3440 m	10 sec/3440 m	10 sec/3440 m	10 sec/3440 m	340 msec/116.9 m
Maximum output power (THD+N < 0.5%, 12 dB crest factor)	4 x 2000 W into 8 ohms 4 x 4000 W into 4 ohms	4 x 800 W into 8 ohms 4 x 1600 W into 4 ohms	4 x 800 W into 8 ohms 4 x 1600 W into 4 ohms	4 x 350 W into 8 ohms 4 x 700 W into 4 ohms	2 x 350 W into 8 ohms 2 x 600 W into 4 ohms
Output routing	Dual Channel, Mix TOP/SUB 2-Way Active	Dual Channel, Mix TOP/SUB 2-Way Active	Dual Channel, Mix TOP/SUB 2-Way Active	Dual Channel, Mix TOP/SUB 2-Way Active	Dual Channel
Output connectors	NL4/EP5 plus central NL8	NL4 plus central NL8	Phoenix Euroblock	Phoenix Euroblock	NL4
GPIO connector, 5 ports	No	No	Phoenix Euroblock	Phoenix Euroblock	No
Cable compensation	LoadMatch	LoadMatch	LoadMatch	LoadMatch	No
Power supply	Autosensing switched mode power supply with active PFC	Universal range switched mode power supply with active PFC	Universal range switched mode power supply with active PFC	Universal range switched mode power supply with active PFC	Autosensing switched mode power supply with active PFC
Mains voltage	100 - 127/208 - 240 V, 50 - 60 Hz	100 - 240 V, 50 - 60 Hz	100 - 240 V, 50 - 60 Hz	100 - 240 V, 50 - 60 Hz	100 - 120/220 - 240, 50 - 60 Hz
Weight (kg/lb)	19/42	10.8/23.8	10.6/23.4	10.6/23.4	8/17.6
Dimensions	2 RU x 19" x 530 mm	2 RU x 19" x 460 mm	2 RU x 19" x 435 mm	2 RU x 19" x 435 mm	2 RU x 19" x 353 mm
Remote	OCA via Ethernet/CAN	OCA via Ethernet/CAN	OCA via Ethernet/CAN	OCA via Ethernet/CAN	CAN
Airflow					

The operation with d&b amplifiers

Amplifier controller setups

Passive and 2-Way Active operation

The D6, D20, D80, 10D and 30D amplifiers can drive the MAX2, M6 and M4 passively. The D20, D80, 10D and 30D can also drive the M6 and M4 in 2-Way Active mode. The M2 can only be driven in 2-Way Active mode with the D80 or 30D amplifiers.

CUT mode

Set to CUT, the cabinet low frequency level is reduced and is configured for use with d&b active subwoofers.

HFA mode

In HFA mode (High Frequency Attenuation), the HF response of the system is rolled off. The HFA provides a natural, balanced frequency response when a unit is placed close to listeners in near field or delay use. High Frequency Attenuation begins gradually at 1 kHz, dropping by approximately 3 dB at 10 kHz. This roll off mimics the decline in frequency response experienced when listening to a system from a distance in a typically reverberant room or auditorium.

CPL function

The CPL (Coupling) function compensates for coupling effects between closely coupled cabinets by reducing the low and mid frequency level. CPL begins gradually at 1 kHz, with maximum attenuation below 400 Hz (for M2 250 Hz), providing a balanced frequency response when monitors are used in pairs. The CPL function can be set in dB attenuation values between -9 and 0, or a positive CPL value which creates an adjustable low frequency boost around 65 Hz (0 to +5 dB).

MAX2 operation with other amplifiers

The MAX2 may be driven by any high quality linear power amplifier provided the output power does not exceed 800 Watts into 8 ohms and an additional subsonic filter (25 Hz and 12 dB/octave) is used.

Recommended amplifiers

	MAX2	M6	M4	M2 ¹
D20	x	x	x	
D80				x
30D	x	x	x	x

Maximum loudspeakers per amplifier channel in passive mode

	MAX2	M6	M4
	2	2	2

Maximum loudspeakers per amplifier in 2-Way Active mode

	M6	M4	M2 ¹
D20	4	4	
D80	4	4	4
30D	4	4	4

Available controller settings

	MAX2	M6	M4	M2 ¹
CUT	x	x	x	x
HFA	x	x	x	
CPL	x	x	x	x

The Stage monitors frequency responses

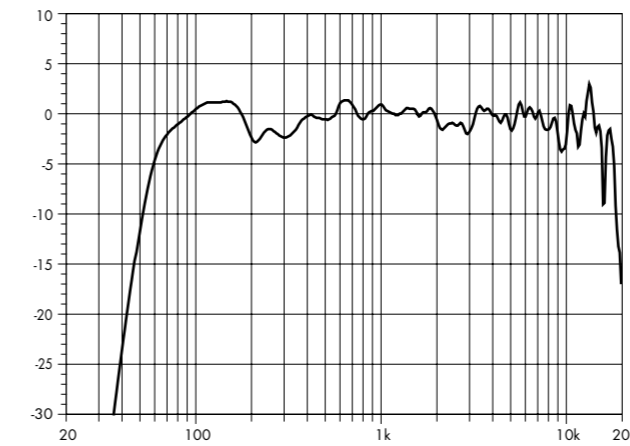

MAX2 configuration standard (floor coupling)

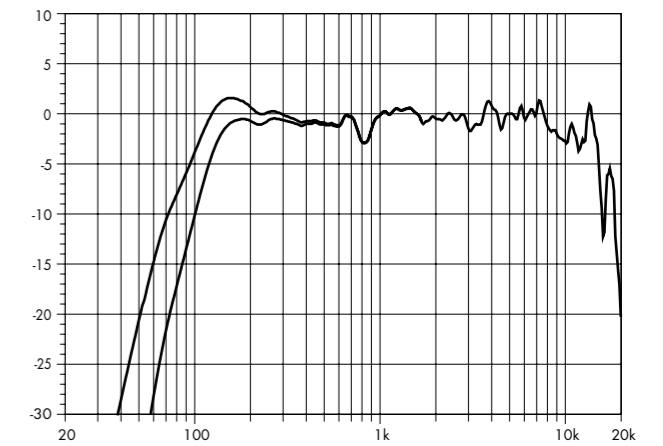

MAX2 linear setup standard and CUT (free field)

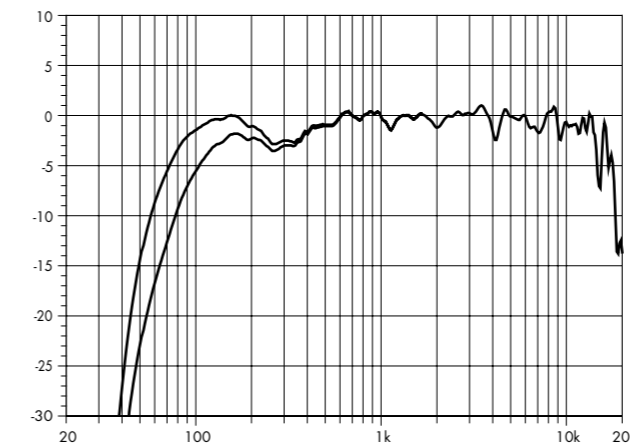

M6 standard and CUT (floor coupling)

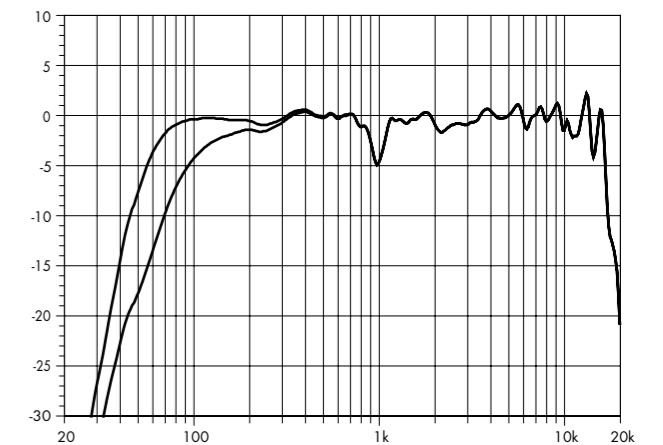

M4 standard and CUT (floor coupling)

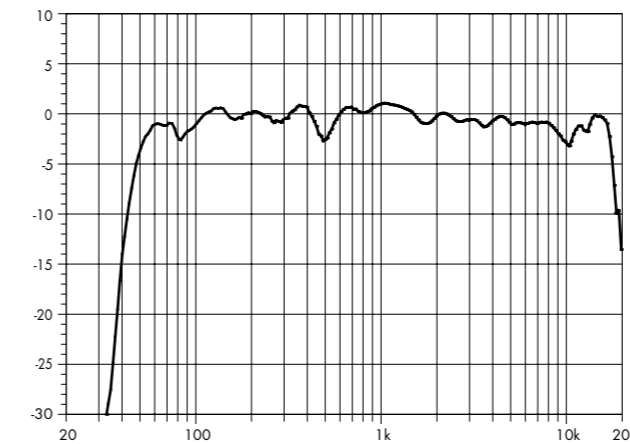

M2 standard

The d&b amplifier output modes

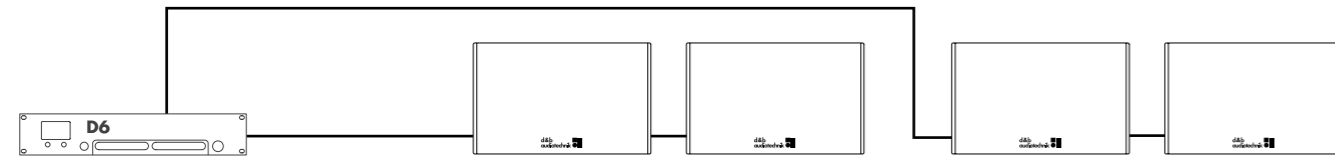

D6 amplifier in Dual Channel mode for MAX2, M6 and/or M4

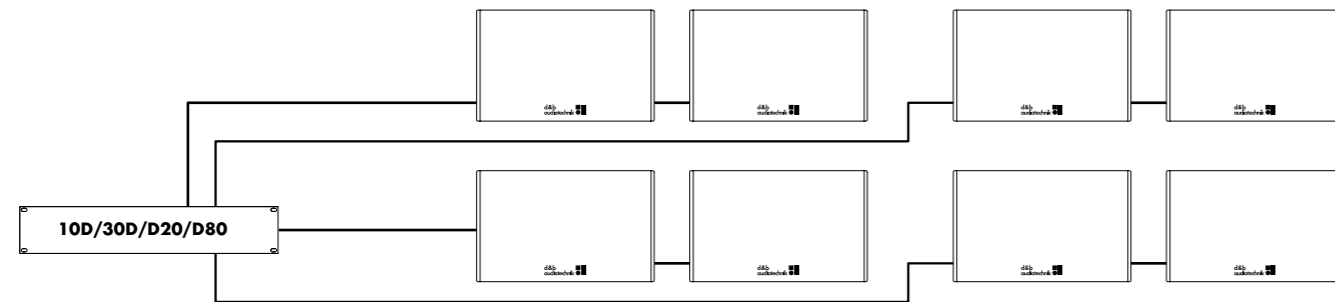

10D/30D/D20/D80 amplifier in Dual Channel mode for MAX2, M6 and M4



10D/30D/D20/D80 amplifier in mixed configuration with Dual Channel mode for MAX2, M6, M4 and 2-Way Active mode for M6 and M4

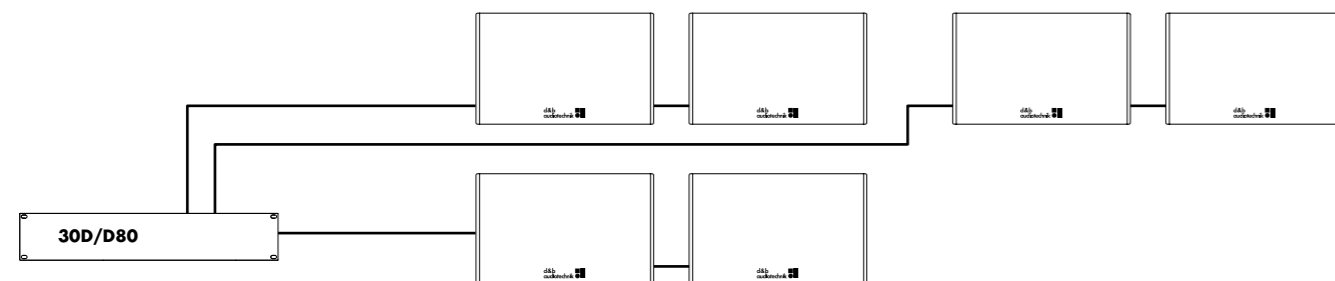

30D/D80 amplifier in mixed configuration with Dual Channel mode for MAX2, M6, M4 and 2-Way Active mode for M6, M4 and M2

The DS10 Audio network bridge

The DS10 Audio network bridge interfaces between Dante networks and AES3 digital audio signals, while also providing distribution of Ethernet control data. Positioned within the signal chain in front of the amplifiers, this 1 RU device expands the d&b system approach in both mobile and installation environments. Each unit can deliver up to sixteen Dante network channels via AES3 digital signal outputs. The AES3 channel streams from the DS10 carry meta data with Dante channel labels and cabling information to the four channel d&b amplifiers. Additionally, four AES3 input channels provide access to the Dante audio network for applications such as a break-in from a Front of House console. The DS10 incorporates an integrated 5-port switch, offering a primary and redundant network for the Dante protocol, as well as advanced functions such as Multicast Filtering and VLAN modes. This extensive switch flexibility provides extended connectivity for a laptop to control the d&b amplifiers using the R1 Remote control software via the OCA (Open Control Architecture) protocol. Using the DS10 Audio network bridge, audio signals and remote control data can be combined using a single Ethernet cable.

The DS10 features a power supply suitable for mains voltages 100 V - 240 V, 50 - 60 Hz, with Overvoltage protection of up to 400 V.

Control and indicators

BYPASS/NETWORK..... Toggle switch
 Switch port modes/Audio loss..... LED indicators
 SYNC ERRORRed LED indicator
 SUBSCRIBED (RX Subscription) Green LED indicator

Connectors

DIGITAL IN.....3 pin XLR female AES3
 Input sampling 32 - 192 kHz
 Input synchronization..... Sample Rate Converter (SRC)
 DIGITAL OUT3 pin XLR male AES3
 Output sampling 48/96 kHz
 Output synchronizationDante network
 NetworketherCON¹
 built-in 5-port Ethernet switch
 100/1000 Mbit

Power supply

Mains connector.....powerCON¹
 Rated mains voltage 100 - 240 V, 50 - 60 Hz

Dimensions, weight

Height x width x depth.....1 RU x 19" x 232 mm
 Weight..... 3.75 kg (8.26 lb)

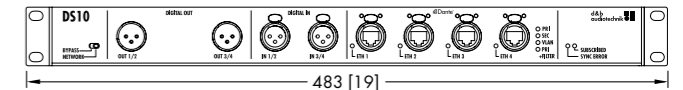

Front view

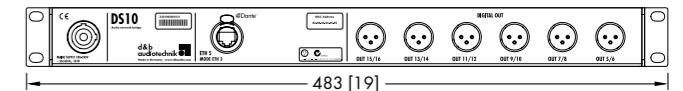

Rear view

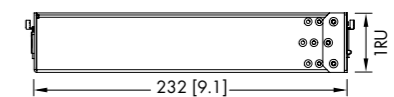

Side view

DS10 Audio network bridge dimensions mm [inch]

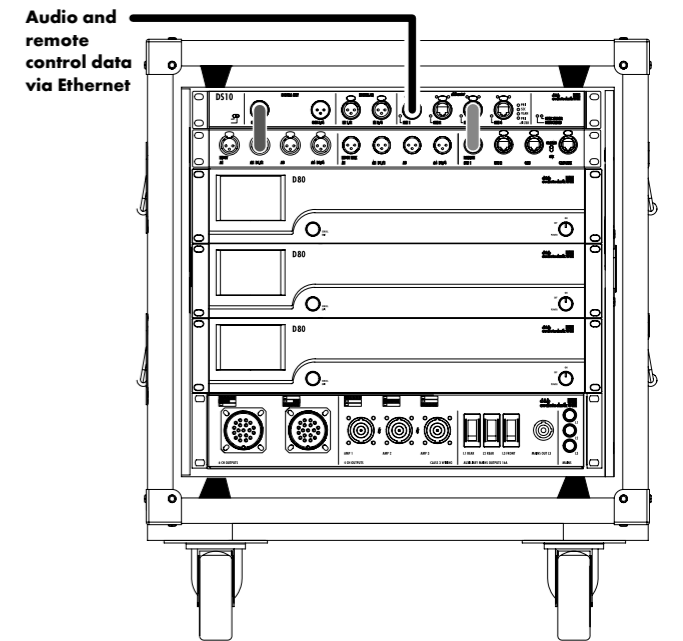

DS10 sending audio and remote control data to D80 amplifiers

¹ etherCON® and powerCON® are registered trademarks of Neutrik AG, Liechtenstein

The Stage monitors cables and adapters

Amplifiers in Dual Channel mode

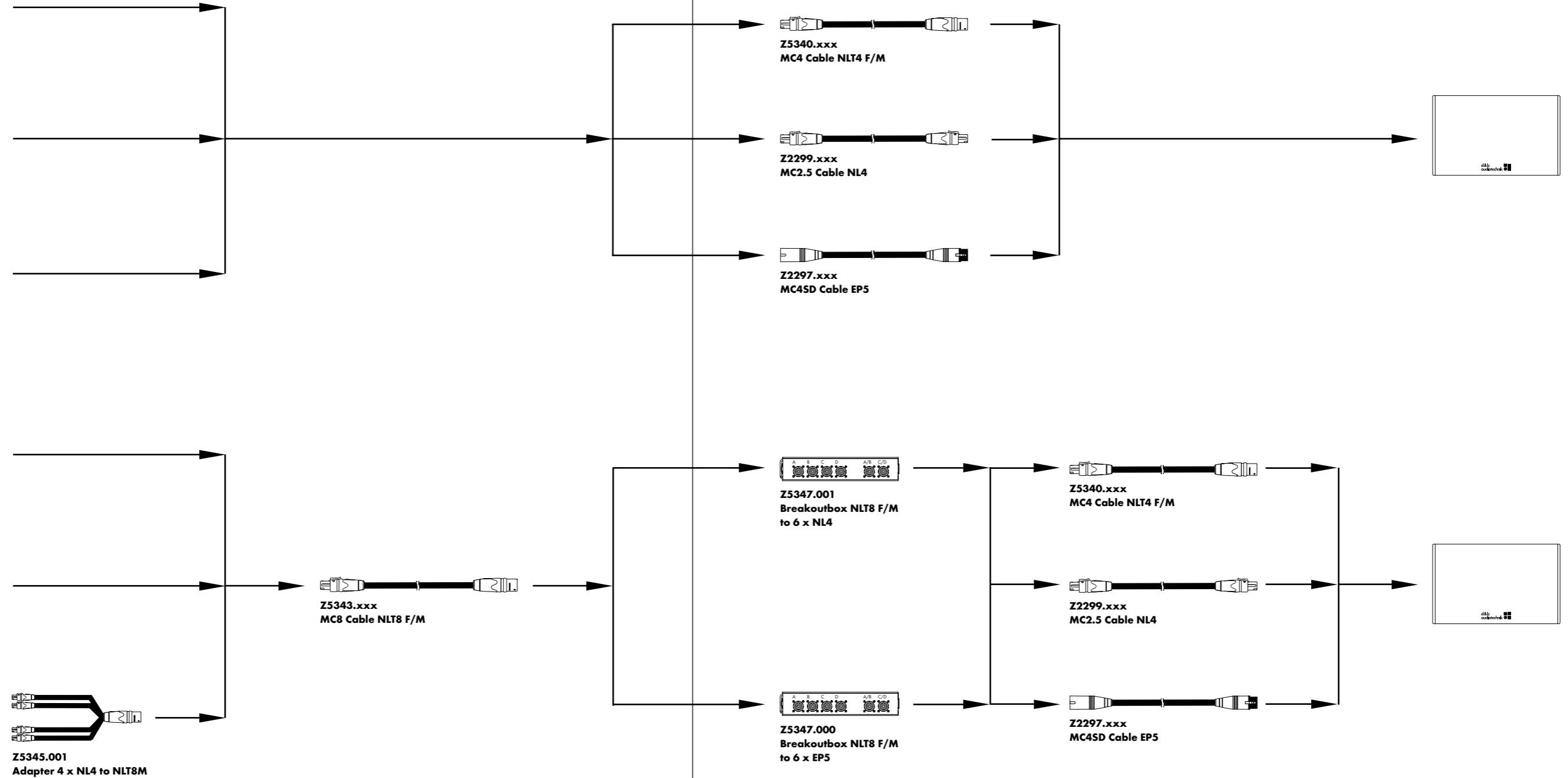
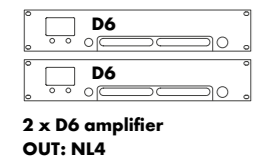
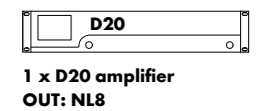
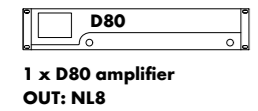
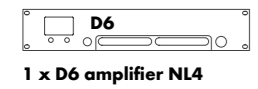
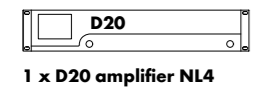
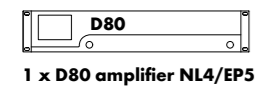

The Stage monitors product overview

Loudspeakers	Z1120.000	MAX2 Monitor EP5 connector
	Z1120.001	MAX2 Monitor NL4 connector
	Z1120.002	MAX2 Monitor NLT4 F/M connector
	Z0820.000	M6 Monitor EP5 connector
	Z0820.001	M6 Monitor NL4 connector
	Z0820.002	M6 Monitor NLT4 F/M connector
	Z0800.000	M4 Monitor EP5 connector
	Z0800.001	M4 Monitor NL4 connector
	Z0800.002	M4 Monitor NLT4 F/M connector
	Z0061.020	M2 Monitor EP5 connector
	Z0061.600	M2 Monitor NL8 connector
	Z0061.002	M2 Monitor NLT4 F/M connector
	Loudspeaker cases	E7467.000
E7437.000		Touring case 2 x M6 tray, wheels
E7425.000		Touring case 2 x M2 door, moulded speaker profile, wheels
Accessories	Z5043.000	MAX Horizontal bracket
	Z5044.000	MAX Bracket connector (supplied in pairs)
	Z5057.000	M6 Flying bracket
	Z5056.000	M4 Flying bracket
	Z5175.000	Qi Horizontal bracket
	Z5020.000	Flying adapter 02
	Z5025.000	Flying adapter 03
	Z5010.000	TV spigot with fixing plate
	Z5015.000	TV spigot for flying adapter 02
	Z5012.500	Pipe clamp for TV spigot
	Z5009.000	Loudspeaker stand with winder
	Z5013.000	Loudspeaker stand winder M20
	Z5024.000	Loudspeaker stand adapter
	Z5048.000	Flying pin 10 mm
	Remote network	Z3010.000
Z6118.000		R60 USB to CAN interface
Z6124.000		R70 Ethernet to CAN interface
Z6116.000		RJ 45 M Terminator
Z6122.000		Bopla mounting clamp
Z6123.000		Bopla mounting clamp upright
Amplifiers	Z2710.xxx	D80 Amplifier ²
	Z2750.xxx	D20 Amplifier ²
	Z2770.xxx	30D Amplifier ³
	Z2760.xxx	10D Amplifier ³
	Z2700.xxx	D6 Amplifier ²

¹ Available as a download at www.dbaudio.com

² The complete list of mobile amplifier versions is available in the D Amplifier and Software brochure

Audio networking	Z4010.000	DS10 Audio network bridge
	Z5563.000	DS10 Rack upgrade kit
	Z5339.000	Multichannel extension cable
Amplifier rack assemblies	Z5560.000	D20 Touring rack assembly CEE 32A 5P, NL4 ⁴
	Z5561.000	D20 Touring rack assembly CEE 32A 5P, NL4, DS10 ⁴
	Z5330.001	D80 Touring rack assembly, CEE 32A 5P, NL4 ⁴
	Z5562.001	D80 Touring rack assembly, CEE 32 A 5P, NL4, DS10 ⁴
	Z5330.xxx	D80 Touring rack assembly, Nema L21-30 (120V devices) on request ⁴
Amplifier racks	E7480.000	D20 Touring rack 2 RU 19" SD, shock mounted, handles, window
	E7468.000	D80 Touring rack 2 RU, 19" SD, shock mounted, handles, window
Cables	Z5343.xxx	MC8 Cable NLT8 F/M
	Z5346.000	Adapter 4 x EP5M to NLT8M
	Z5345.001	Adapter 4 x NL4 to NLT8M
	Z5344.002	Adapter NLT8F to 4 x NLT4M
	Z5344.001	Adapter NLT8F to 4 x NL4
	Z5344.000	Adapter NLT8F to 4 x EP5
	Z5347.001	Breakoutbox NLT8 F/M to 6 x NL4
	Z5347.000	Breakoutbox NLT8 F/M to 6 x EP5
	Z5340.xxx	MC4 Cable NLT4 F/M
	Z2299.xxx	MC2.5 Cable NL4
	Z2297.xxx	MC4SD Cable EP5
	Z2298.xxx	MC2.5SD Cable EP5
	Z5348.002	Adapter NLT8F 2-way to 2 x NLT4M
Z5348.003	Adapter NLT8M 2-way to 2 x NL8	
Z5348.000	Adapter NLT8F 2-way to 2 x EP5F	
Misc.	Z5060.000	Anti-slip coating 1kg/2.2 lb
	Z5061.000	Standard cabinet paint 1 kg/2.2 lb

³ The complete list of installation amplifier versions is available in the xD Installation Amplifier and Software brochure

⁴ Further information is available in the D Amplifier and Software brochure

